

## Adapting the pulsed GMAW process to varying conditions of use

Dr.-Ing. Birger Jaeschke, Lorch Schweißtechnik GmbH, Auenwald, Germany, 07/06/16  
Dipl.-Ing. Philipp Lozano, Welding and Joining Institute (ISF) at RWTH Aachen University

The synergetic programs incorporated into welding power sources designed for pulsed gas-shielded metal-arc welding (GMAW) applications have been devised for specific conditions of use by their manufacturers. These conditions of use include, first and foremost, the characteristics of wire and material as well as the process gas used. Other conditions of use such as welding speed, welding position, torch distance, weld seam geometry and heat dissipation increase in relevance if their modification becomes crucial to the welding outcome. Against this backdrop, this document will examine the development of a special pulsed GMAW concept. As it turns out, the conversion of an U-I control to an I-U-I control improves the pulse welding characteristics of the control to such an extent that the associated process control can be adapted to different conditions of use with exceptional stability.

### 1 A historic overview of control concepts

A look back in history helps understand how the different pulse welding variants can be categorised, see Technical Bulletin DVS 0926-3 [1].

Pulsed power sources for GMAW applications became available as early as the mid-1960s. The power semiconductors available at the time (thyristors) did not allow for more than influencing the welding current in sync with the mains supply. This limitation resulted in the key pulse welding parameter, the pulse frequency, being linked to the mains frequency (50 Hz in Europe) by specific factors. The manual parameters that could be set included the pulse duration, the pulse amplitude (pulse voltage U) and the voltage between the pulses (basic voltage U). Back then, a welding inductor acted on the current dynamics, making it possible to influence how "hard" the pulsing was going to be. The arc length was regulated based on the "internal" control in conjunction with the welding process and the welding power source. An increase in welding process voltage would lead to an augmentation of the pulse current level and the basic current and vice versa. Today's accepted classification groups this type of control as the U-U characteristic for pulse welding.

The mid-1980s introduced power supply units equipped with transistors that allowed for operation independent of the mains frequency. These units, furthermore, allowed for a degree of current control that made it possible to keep the arc stable during the basic current phase

(basic current I) even at low current levels. This innovation also brought along U-I control including enhanced welding process characteristics. The possibilities multiplied thanks to the option of dynamically simulating the welding current inductor with the control system.

The arrival of microprocessors established digital technology as the main technology used for the controls regulating welding power sources. Digital technology now put operators in a position to implement control concepts that utilised mathematical algorithms which could be based on an even larger number of parameters. It also became possible to use the pulse frequency itself to control the process (in particular, the arc length). This period witnessed the introduction of the I-I control concept which involves, aside from controlling the basic current, the control of the current generated during the pulse (pulse current I) based on specific criteria. Technology progressed such that the computational and storage power of today's power source controls combined with the response time of modern power supply units has given rise to an extensive mix and expansion of various different control concepts.

Until recently, the prevailing trend was to opt for highly specialised modifications of certain pulse welding processes in an effort to adapt to particular conditions of use. In summary, the historic developments in the field of pulse welding, e.g. U-I control, have retained specific characteristics that remain relevant to certain aspects of today's process technology (thus, possessing not only historically overcome disadvantages but also benefits).

## 2 Comparison of the basic control concepts

The control strategies behind I-I control and U-I control are vastly different and offer various downsides and advantages.

The foremost benefit of I-I control is that it guarantees the detachment of the droplet by means of a constant current pulse across a wide control range, thereby preventing spatter. Disadvantages: The regulation of the arc length requires that the pulse frequency and other parameters be modified by the power source control, **Fig. 1**. This necessity is audible and manifests itself as an "impure" (non-constant pulse frequency). Short-term faults during the measurement of the arc voltage at specific points, e.g. caused by worn contact tubes, can result in comparatively severe faults during the stabilisation of the arc length.

The benefits the historically older U-I control has to offer and that are of primary importance to certain applications outweigh the disadvantages of the I-I control. Short-time faults during the measurement of the arc voltage only have a minor impact as the U regulation phase interprets the long rather than the short arc voltage periods. The U regulation phase responds immediately with a change of current during the ongoing pulse, **Fig. 2**. Since nearly constant, the pulse repetition frequency sounds stable from an acoustic standpoint. However, one major downside of U-I control when contrasted with I-I control is that the droplet may fail to detach when the pulse current amplitude is lowered on account of the higher voltage associated with a longer arc. This failure will result in a process disruption including spatter.

### I-I control (pulsed current I, basic current I)

Benefits	Disadvantages	Characteristics
wide control range, steep possible controller response, ensures that the droplet detaches reliably	subjective impression of unstable process (frequency changes)	allows for integral action of the arc length stabilisation

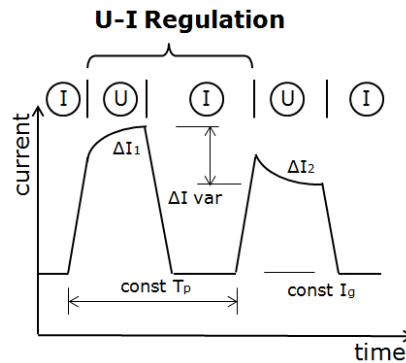

Fig. 2

### U-I control (pulsed voltage U, basic current I)

Benefits	Disadvantages	Characteristics
inherent, immediate, constant frequency (subjectively perceived as pleasant), Selection of the frequency	limited control range, Possible degeneration of the droplet detachment	proportional action of the arc length stabilisation

### I-I Regulation

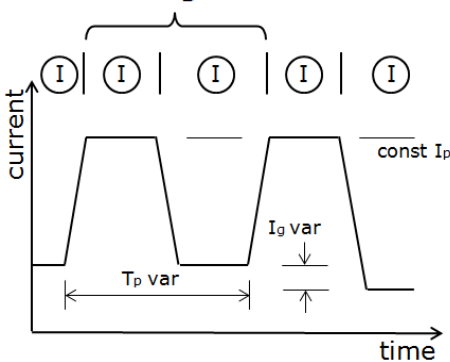

Fig. 1

1

## 3 Expansion of control concepts

The options to modify the pulsed arc that are available today (in addition to the U-I and I-I control concepts) are used to optimise certain process characteristics. Technical Bulletin DVS 0973 [2] lists the following modifications as ways to shape certain characteristics:

- Departures from the convention of the "one-droplet-per-pulse" principle;
- optional use of current or voltage control during the pulse phase;
- Shortening of the arc length to create a pulse-induced metal transfer during a

controlled short-circuit phase in an effort to combine the characteristics of the pulse arc with those of the short arc in a favourable way;

- Utilisation of a brief spray arc phase that follows the pulse temporarily with the objective to combine the characteristics of the pulse arc with those of the spray arc in a beneficial way.

The abundance of ways in which pulsed welding can be adapted to various conditions of use electrifies the majority of welding coordinators:

- What are the requirements of the joining connection / welding process?
- Personal preferences: what is the welder's / welding coordinator's favourite approach?
- What is the extent of variation?
- What are the capabilities of the welding power source?

A bilateral research project conducted by ISF Aachen [3] and Lorch Schweißtechnik [5] zeroed in on all of these questions. The objective behind this project was to devise a reliable solution that is supposed to put the welder in a position where he can adjust the pulse welding process to varying conditions of use with complete ease by means of a welding power source that boasts fully digital control.

#### **4 Approach for "varying conditions of use"**

"Varying conditions of use" subsume applications that involve changing and even conflicting requirements. Examinations of the state of the art, surveys of unsuspecting welders, and evaluations of existing process parameter and process measurement data that also considered the expertise and potential of the two project partners revealed that the user would benefit the most from a solution that is particularly robust.

The cornerstones of this approach are:

- Inclusion of the welder's present reaction to varying conditions of use, which is dominated by the experience he has made previously (intuition);
- I-U-I control of the pulse welding process to exploit the self-regulating effects of the free end of the wire and the arc length (inherence);

- Utilisation of arc length and pulse frequency as a means to adapt to "varying conditions of use" (variability).

The following is a detailed description of these cornerstones.

#### **Intuition**

While welding, many welders respond to an arc that they perceive as too short by retracting the torch, intuitively expecting the arc length and the stick out of the wire to increase. Conversely, the response by many welders to an arc that they consider to be too long or to the onset of undesired arc deflection (e.g. brought about by arc blow) consists in shortening the torch distance or changing the tilt of the torch. Similar reactions (that also make sense) can be found when analysing the approaches pursued by welders when welding over tack welds or overcoming other types of seam challenges. Welders performing conventional GMAW tasks in the short, globular and spray arc range are used to adjusting the arc by changing the torch distance - either from short and aggressive (crisp) to longer and wider. The new control of the welding power source is intended to allow for these immediate intuitive reactions of the welder. This choice of control is deliberately different from other control strategies which are designed to have the welding process control keep the arc length perfectly constant regardless of how the torch is held and irrespective of the free end of the wire.

#### **Inherence**

The two other cornerstones of the approach were achieved by implementing a new I-U-I pulse process control that is rooted in the classic control strategies I-I and U-I (**Fig. 1, Fig. 2**) and also capitalises on the effect of a beneficial modification of the pulse welding process (**Fig. 3**).

What the I-U-I pulse process control retains from the traditional I-I control is its inherent reliability that provides for a stable basic current and a droplet formation that is in sync with the pulse, thereby guaranteeing low-spatter metal transfer across a wide current and melt-off capacity range. The fundamental improvement lies in the known modification of the pulse welding process [6], which is furnished with special characteristics by an additional, secondary metal transfer that resembles

a spray arc and takes place during the narrow time interval following the shaping of the guide droplet (**Fig. 3**). It is controlled as a patented innovation [8] during the second phase towards the end of the U pulse (**Fig. 4**). This innovation allows the current level and, thus, the extent of the additional metal transfer to automatically react to the arc length and the free end of the wire. Consequently, it enables the arc length to inherently (independently) stabilise, featuring characteristics that are similar to the ones found in the widely used plain MSG welding process with a nearly horizontal output characteristic of the welding power source. It also falls neatly in line with the welder's intuition. What is more, the arc length stabilisation inherent in I-U-I pulse process control makes the pulse frequency available again as a flexible setting parameter.

- stick out of the wire, arc length, arc shape;
- Metal transfer (droplet size, droplet quantity, droplet shape, length of time);
- Melt (size, flow, solidification profile, heat penetration zone);
- Energy balances.

Since many welders have become accustomed to altering the arc length using the "arc length" correction parameter, the new approach has retained this option. The new approach, furthermore, allows the welder to variably adjust the pulse frequency with the help of an additional correction parameter. Both adjustment options, just as all other parameters, can be selected using the controls included on the power source, the wire feeder or the torch. The experts participating in the project did, however, hold opposing views as to how the term "variability" is to be interpreted correctly. While the scientific camp among them attached greater importance to process characteristics that are quantifiable from an orthogonal standpoint, the pragmatists among the welding experts were emphasising setting parameters that bring about "something meaningful". Both views placed equal significance on retaining process reliability, which stems from setting the proper parameters for the synergy characteristics of the welding power source.

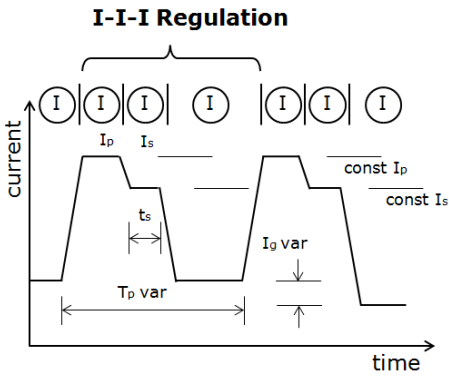

Fig. 3

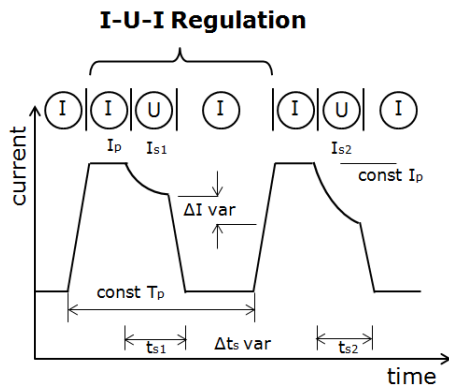

Fig. 4

**Variability**

With the wire feed speed constant and the welding speed defined, the pulse frequency and the electric energy converted during the individual pulse intervals exert a major influence on the arc range. The partners cooperating in the research project systematically examined the following as possible variable parameters of the arc range:

**5 Findings of the systematic studies**

Supported by the Leibniz Institute for Plasma Science and Technology INP Greifswald [4], the project used 3 synchronised high-speed cameras with different exposure times and adapted spectral filters to systematically capture and evaluate video footage that recorded the melt, the metal transfer and the arc-metal vapour region, **Fig. 5**.

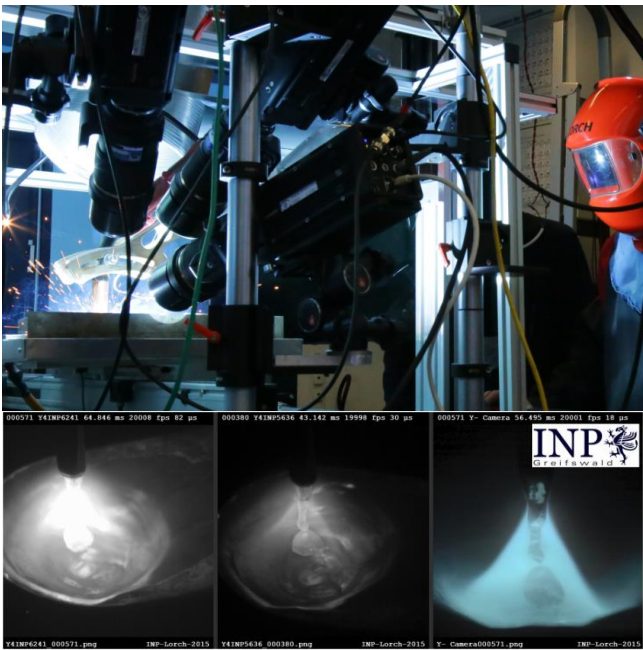
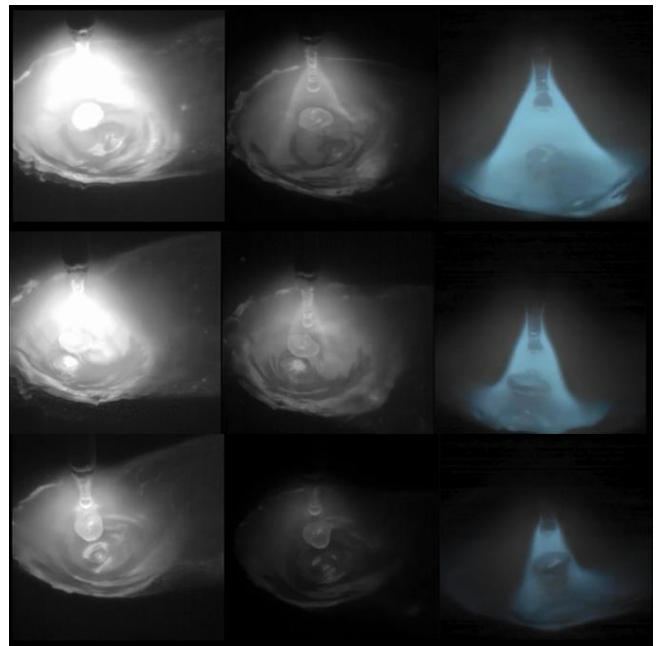

**Fig. 5:** Test set-up including high-speed cameras (top) and synchronised images of the melt (left), the metal transfer (centre) and the arc-metal vapour region (right) found in the examined I-U-I pulsed process (inert gas M21, 1.2mm G3Si1, vD=12.5m/min, vS=75cm/min)

The project confirmed that the inherent arc length stabilisation is linked to the amount of additional material that was melted off by the excitement brought about by the exposure to current during the U regulation phase. Provided that the melt-off rate of the electrode (which corresponds, on average, to the set wire feed speed) is identical, a lower pulse frequency requires a larger melt-off volume per pulse than a higher pulse frequency. During the initial I phase the I-U-I control now provides for a reliable detachment of the main droplet (primary droplet), **Fig. 6**.

The tests showed that the primary guide droplet retained an identical size regardless of the setting chosen for the pulse frequency. The change to the material melted off and transferred from the electrode per pulse mainly occurs during the secondary spray arc phase.

**Fig. 7** reveals that the chain of droplets that is shaped like a spray arc encompasses a greater material volume (longer chain of droplets) at the lower frequency (top image series) than at the higher frequency (lower images series).



**Fig. 6:** the main droplet (primary guide droplet) preserves a similar size even though the settings of the pulse frequency vary (high frequency in the top image sequence, low frequency on the bottom)

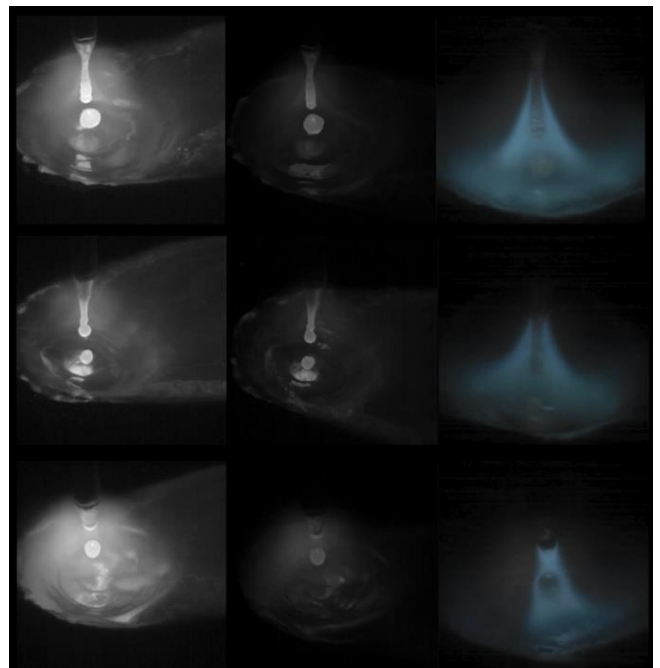

**Fig. 7:** the main droplet following the secondary metal transfers, which resembles a spray arc, has a volume per pulse that varies with and adapts to the setting of the pulse frequency (high frequency at the top, low frequency at the bottom).

This cause-and-effect relationship makes it possible to select different values for the pulse frequency without suffering any disadvantages during the reliable detachment of the main droplet, which is essential to achieving a low-spatter pulse process.

Put in oversimplified terms, the cause-and-effect correlation in the inherent interdependency of stick-out and arc length is similar to conventional MSG welding in that a shorter arc results in a current increase during the U regulation phase of the I-U-I process control, which, in turn, leads to a higher melt-off rate in the electrode. Conversely, the current is reduced when the arc is longer.

This behaviour contributes to a comparatively robust stabilisation of the welding process even though the arc length is not kept as constant as during an I-I-controlled pulse process. This is largely due to the fact that this characteristic of the I-U-I control is detected by the welder's "intuition" and exploited accordingly.

While not immediately obvious at first glance, the mechanised welding process draws a succinct advantage from the I-U-I control - even without any "intuition". This advantage lies in the robustness of the "inherent" control. On the other hand, the suspected disadvantage associated with the fact that the arc length is not fully stabilised during a change of distance is insignificant, seeing as welders usually avoid changes of distance when the torch is guided mechanically.

The robustness of the "inherent" control can be attributed to the fact that the U regulation phase is a period of time rather than a single point in time during which any short-term faults (e.g. the constant contact alterations in the contact tube) are evened out before they can become disruptive - as may be the case, for example, during the measurement of the arc voltage for the control circuit of the I-I pulse process control.

**Fig. 8** shows the times and images of the metal transfer during certain phases of the process as a function of the current and voltage progressions over time. The upper and lower series of images depict the ratios for a relatively short and a relatively long arc, respectively. They reveal that the resulting current profile during the U regulation phase affects the pulsed metal transfer - both with regard to the

time when and the magnitude with which certain characteristics materialise.

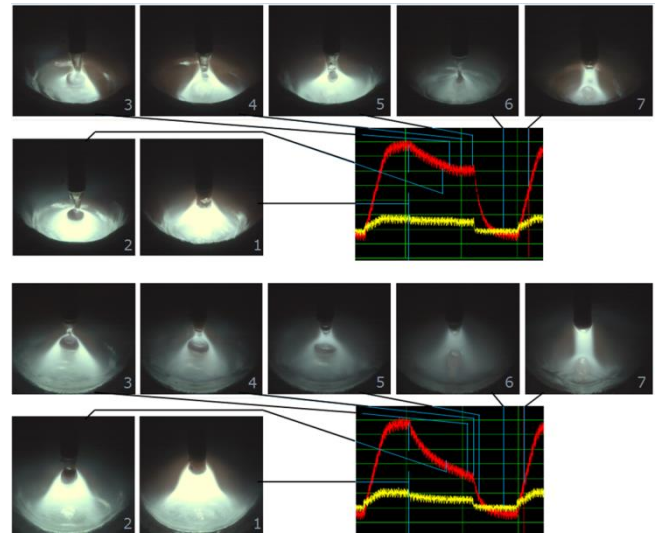

**Fig. 8:** Times and images of the metal transfer during specific phases of the process: Beginning of the U regulation phase (1), droplet constriction (2), droplet detachment (3), secondary spray arc phase (4), end of pulse (5), basic current phase (6), beginning of pulse (7); shorter arc (top); longer arc (bottom)

The conducted systematic examinations - complemented by the development of synergy characteristics - focus on the detection / verification of analytical links that have been predicted to exist between various setting and process parameters. Front and centre during these examinations was the effort to devise a process control variant capable of showing a "well-tempered (robust) reaction" to changes in the conditions of use.

**Figs. 9 to 16** represent excerpts of the results systematically established during the examinations related to the application of the I-U-I process control variant (SG3Si1, inert gas Ar/CO2 92/08,  $t=10\text{mm}$ ,  $vD=9.5\text{m/min}$ ,  $vS=60\text{cm/min}$ ).

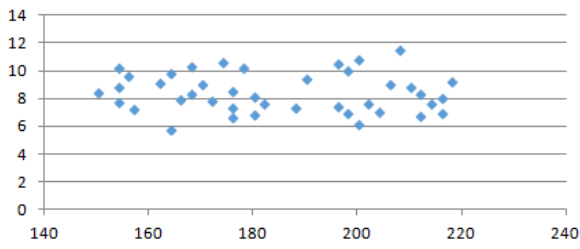

**Fig. 9:** Statistical trial matrix of the samples under examination. Depicted is the arc power in kW (Y-axis) as a function of the pulse frequency in Hz

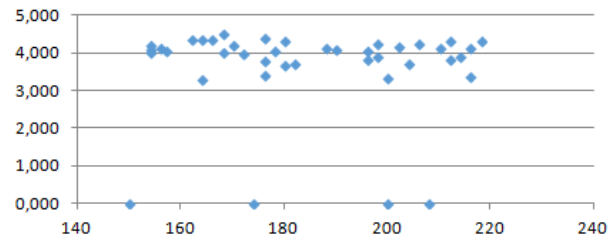

**Fig. 13:** Illustration of the determined penetration depth H2 in mm as a function of the pulse frequency in Hz (0=selected outliers)

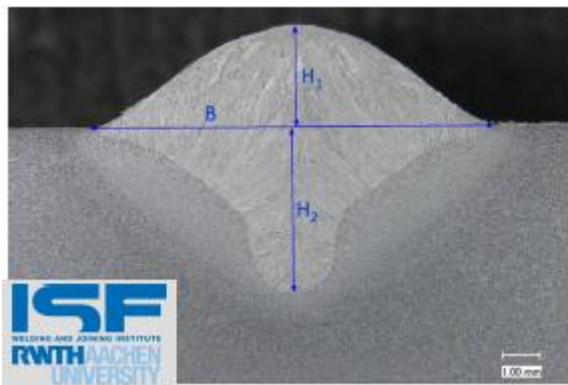

**Fig. 10:** Illustration of the examined geometric length characteristics of the seam cross section

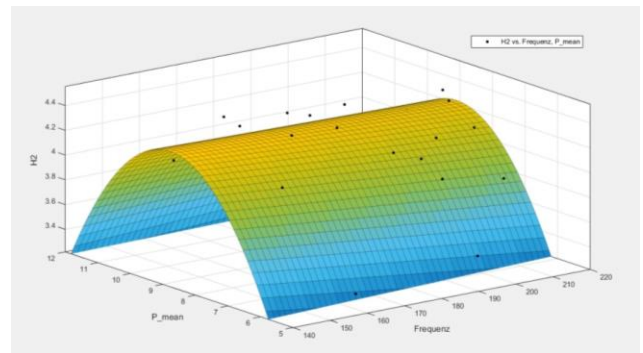

**Fig. 14:** Illustration of the determined penetration depth H2 in mm as a function of the arc power in kW and the pulse frequency in Hz

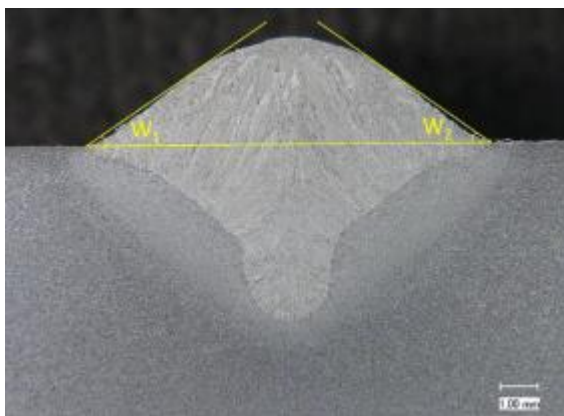

**Fig. 11:** Illustration of the examined geometric angle characteristics of the seam cross section

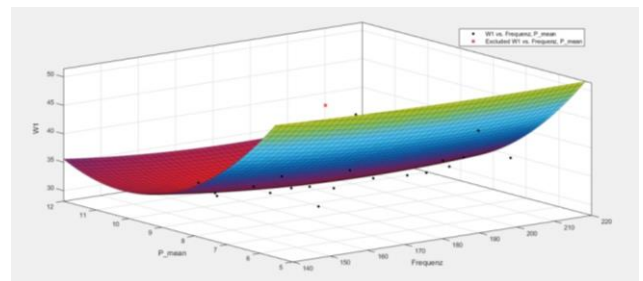

**Fig. 15:** Illustration of the determined angle W in degrees as a function of the arc power in kW and the pulse frequency in Hz

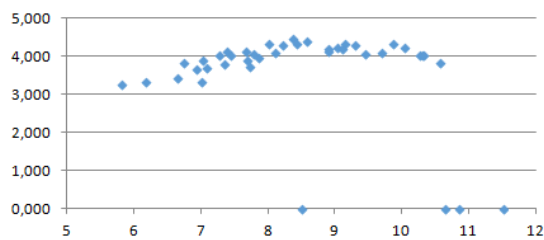

**Fig. 12:** Illustration of the determined penetration depth H2 in mm as a function of the arc power in kW (0=selected outliers)

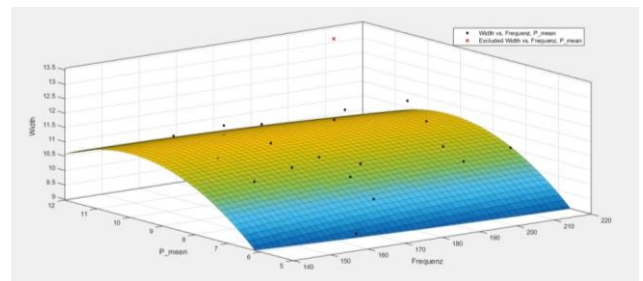

**Fig. 16:** Illustration of the determined seam width B in mm as a function of the arc power in kW and the pulse frequency in Hz

As the 2-D and 3-D evaluations uniformly show, the determined geometric characteristics of the seam do not systematically depend on the pulse frequency. It could be established, however, that there is a systematic (non-linear) dependence of the seam's geometric characteristics on the electric power of the arc. The findings confirm that the true arc power is equally vital to the examination of the I-U-I pulse process control variant as for other types of process control variants. These findings are consistent with existing examinations and conclusions regarding the influence of pulsed process parameters on heat input [7]. The results of the systematic examinations suggest that the variant is suitable for a wide range of possible applications.

## 6 Field test and launch for industrial use

The new pulse process control variant, which can be adapted to varying conditions of use by means of "intuition", "inherence", and "variability", was subjected to a rigorous field test in 2015 which was conducted by a string of highly discriminating industrial users.

The participants in this field test subjectively perceived the constant pulse frequency along with the distinctly robust process-related characteristics as more pleasant and, thus, considered the process overall to be more stable compared to the pulse frequency control applied during conventional I-I-controlled pulse processes.

In a welcome contrast to the hard-to-grasp scientific statements about the special characteristics of the new pulse process control variant, one of the field test participants finally managed to come up with a short-and-sweet description: "Some cars have front-wheel drive, while others operate with rear wheel drive or, at times, a differential lock. This new variant now represents the all-wheel drive among pulse processes".

Thanks to the consistently positive feedback it received, the new pulse process control variant was launched by Lorch for industrial applications under the label "SpeedPulse XT" in early 2016. Certified procedure qualification tests including welding procedure specifications (WPS) derived from these tests are available.

The following is an example of a complex task that was accomplished by incorporating the new variant into the automated welding operations performed at a manufacturer of bicycle frames, **Fig. 17**. The orientation of the torch passes positions PA, PB, PG, and PD, while the flank angles simultaneously change at the stationary pipe segment. The manufacturer was able to achieve the required quality and efficiency thanks to the combination of a cyclical process that was controlled by an I-U-I pulse process control and an adapted torch trajectory including varying distances of the contact tube to the welding joint.

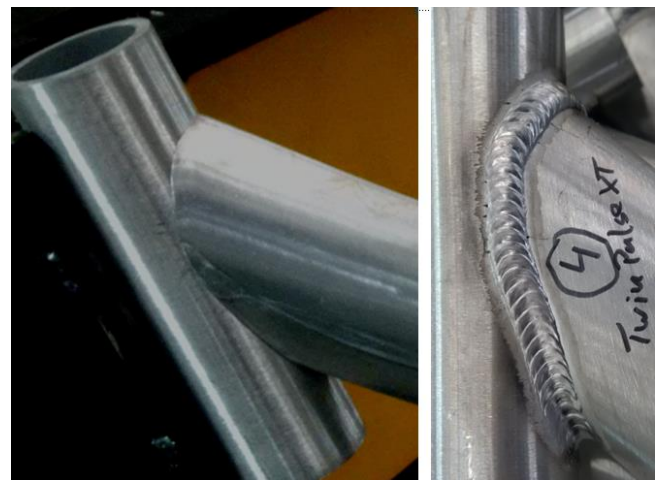

**Fig. 17:** Prepared segments of an aluminium bicycle frame (left), subjected to mechanised MIG welding including a "manual TIG look" (right) and the I-U-I controlled cyclical pulse process variant "TwinPulse XT"

## 7 Conclusion

This document presented the design and examination results of a new patented I-U-I-controlled pulsed welding process that offers particularly robust characteristics ("intuition", "inherence", and "variability"). The description was given in the context of the categorisation of process control variants given in Technical Bulletin DVS 0973 [2] and the Technical Bulletin on controlled pulsed arc processes, DVS 0926-3 [1].

The parameters of the welding program data have been designed such that the user will not experience any impact on process reliability that is systematically negative - despite the variability of the variant, which is beneficial to the user.



One of the most significant advantages this widely applicable I-U-I control variant has to offer involves the welder's ability to rely on his intuition, as the new low-spatter pulse process responds in a "well-tempered", "robust" and "adaptable" manner.

## 8 Sources and references

[1] Prozessparameter und Gerätetechnik für das Impuls-Lichtbogenschweißen, Bulletin DVS 0926-3, DVS Media GmbH, Düsseldorf 2012

[2] Übersicht der Prozessregelvarianten des MSG-Schweißens, Bulletin DVS 0973, DVS Media GmbH, Düsseldorf 2015

[3] Institut für Schweißtechnik und Füge-technik (ISF) der RWTH Aachen, ISF - Welding and Joining Institute, RWTH - Aachen University, Pontstrasse 49, 52062 Aachen, [www.isf.rwth-aachen.de](http://www.isf.rwth-aachen.de)

[4] Leibniz Institute for Plasma Science and Technology (INP) Greifswald, Felix-Hausdorff-Str. 2, 17489 Greifswald, [www.inp-greifswald.de](http://www.inp-greifswald.de)

[5] Lorch Schweißtechnik GmbH, Im Anwänder 24-26, 71549 Auenwald, [www.lorch.eu](http://www.lorch.eu)

[6] B. Jaeschke: Steigerung der Wirtschaftlichkeit des Metall-Schutzgasschweißens durch moderne Schweißgerätesysteme. Yearbook welding technology 2013, pp.182/185, DVS Media GmbH, Düsseldorf 2012

[7] B. Jaeschke, W. Ernst, M. Luritzhofer: Verringerung von Fehlern bei der werkstoffspezifischen Bestimmung von Streckenenergie und Wärmeeinbringung moderner Lichtbogenschweißprozesse. DVS reports Volume 296, DVS Congress 2013, p. 302 et sqq. DVS Media, Düsseldorf 2013

[8] Patent specification DE102010002121B8: Arc welding process and welding power source for executing the process. Patent holder: Lorch Schweißtechnik GmbH. Date of patent grant publication: 28/07/2011